

## DECLARATION OF PERFORMANCE No 34/SZ/16

1. Unique identification code of the product-type: **KPR-FAST-10K , KPS-FAST-10S**

2. Intended use/es:

Product	Intended use
Plastic anchors for use in concrete and masonry	Plastic anchors for multiple use in concrete and masonry for non-structural applications ( use category a, b, c, d) : , See appendix, especially Annexes B 1, B 2

3. Manufacturer: **KLIMAS Sp. z o.o.  
ul. Wincentego Witosa 135/137  
Kuźnica Kiedrzyńska 42-233 Mykanów**

4. Authorised representative: **not applicable**

5. System/s of AVCP: **System 2+**

6. European Assessment Document:

- a) **EAD 330284-00-0604**
- b) **European Technical Assessments – ETA-12/0272 of 19/09/2022**
- c) **INSTYTUT TECHNIKI BUDOWLANEJ – ITB**
- d) **Identification number of notified body– 1488**

7. Declared performance/s:  
**Safety in case of fire (BWR 2)**

Essential characteristic	Performance
Reaction to fire	Anchorage satisfy requirements for Class A1
Resistance to fire	See appendix, especially Annex C 3

### Safety and accessibility in use (BWR 4)

Essential characteristic	Performance
Resistance to steel failure under tension and shear loading	See appendix, especially Annex C 1
Resistance to pull-out or concrete failure under tension loading ( base material group a )	See appendix, especially Annex C 2
Resistance in any load direction without lever arm ( base material group b, c and d)	See appendix, especially Annex C 4
Edge distance and spacing	See appendix, especially Annexes B 3, B 4
Displacements under short-term and long-term loading	See appendix, especially Annexes C 3, C 5

### Aspects of durability

Essential characteristic	Performance
Durability – corrosion of metal parts	- anchor sleeve – no metal parts
	- screw – See appendix, especially Annexes A 15, B 1
Durability – high alkalinity of plastic sleeve	no influence of high alkalinity

8. Appropriate Technical Documentation and/or Specific Technical Documentation: **not applicable**

*The performance of the product identified above is in conformity with the set of declared performance/s. This declaration of performance is issued, in accordance with Regulation (EU) No 305/2011, under the sole responsibility of the manufacturer identified above.*

Signed for and on behalf of the manufacturer by:

Kuźnica Kiedrzyńska  
26.10.2022r.  
(place and date of issue)

Adam Szczepanowski

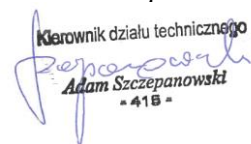

Kierownik działu technicznego  
Adam Szczepanowski  
- 415 -

(signature)

*This declaration replaces the declaration from 26.03.2020.*

*This DoP has been prepared in different languages. In case there is a dispute on the interpretation the english version shall always prevail. The Appendix includes voluntary and complementary information in English language exceeding the (language-neutrally specified) legal requirements.*

## Specific Part

### 1 Technical description of the product

The KPR-FAST, KPS-FAST, KPR/FAST, KPS/FAST, KPR-STRONG and KPS-STRONG anchors consists of a plastic sleeve made of polyamide and an accompanying specific screw made of galvanised or stainless steel.

The plastic sleeve is expanded by screwing in the specific screw which presses the sleeve against the wall of the drilled hole.

The description of the products is given in Annex A.

### 2 Specification of the intended use in accordance with the applicable European Assessment Document (EAD)

The performance given in clause 3 are only valid if the anchor is used in compliance with the specifications and conditions given in Annex B.

The provisions made in this European Technical Assessment are based on an assumed working life of the anchor of 50 years. The indications given on the working life cannot be interpreted as a guarantee given by the producer or Technical Assessment Body, but are to be regarded only as a means for choosing the right products in relation to the expected economically reasonable working life of the works.

### 3 Performance of the product and references to the methods used for its assessment

#### 3.1. Performance of the product

##### 3.1.1. Safety in case of fire (BWR 2)

Essential characteristic	Performance
Reaction to fire	Anchorage satisfy requirements for Class A1
Resistance to fire	Annex C2

##### 3.1.2. Safety and accessibility in use (BWR 4)

Essential characteristic	Performance
Resistance to steel failure under tension and shear loading	Annex C1
Resistance to pull-out or concrete failure under tension loading (base material group a)	Annex C2
Resistance in any load direction without lever arm (base material group b, c and d)	Annex C4
Edge distance and spacing	Annex B3, B4
Displacements under short-term and long-term loading	Annex C3, C5

### 3.1.3. Aspects of durability

Essential characteristic	Performance
Durability – corrosion of metal parts	- anchor sleeve – no metal parts - screw – see Annex A15 and B1
Durability – high alkalinity of plastic sleeve	no influence of high alkalinity

### 3.2 Methods used for the assessment

The assessment has been made in accordance with EAD 330284-00-0604.

### 4 Assessment and verification of constancy of performance (AVCP) system applied, with reference to its legal base

According to the Decision 97/463/EC of the Commission of 27 June 1997 the system 2+ of assessment and verification of constancy of performance (see Annex V to regulation (EU) No 305/2011) applies.

### 5 Technical details necessary for the implementation of the AVCP system, as provided in the applicable European Assessment Document (EAD)

Technical details necessary for the implementation of the AVCP system are laid down in the control plan deposited in Instytut Techniki Budowlanej.

For the type testing the results of the tests performed as part of the assessment for the European Technical Assessment shall be used unless there are changes in the production line or plant. In such cases the necessary type testing has to be agreed between Instytut Techniki Budowlanej and the notified body.

Issued in Warsaw on 19/09/2022 by Instytut Techniki Budowlanej



Krzysztof Kuczyński, PhD  
Deputy Director of ITB

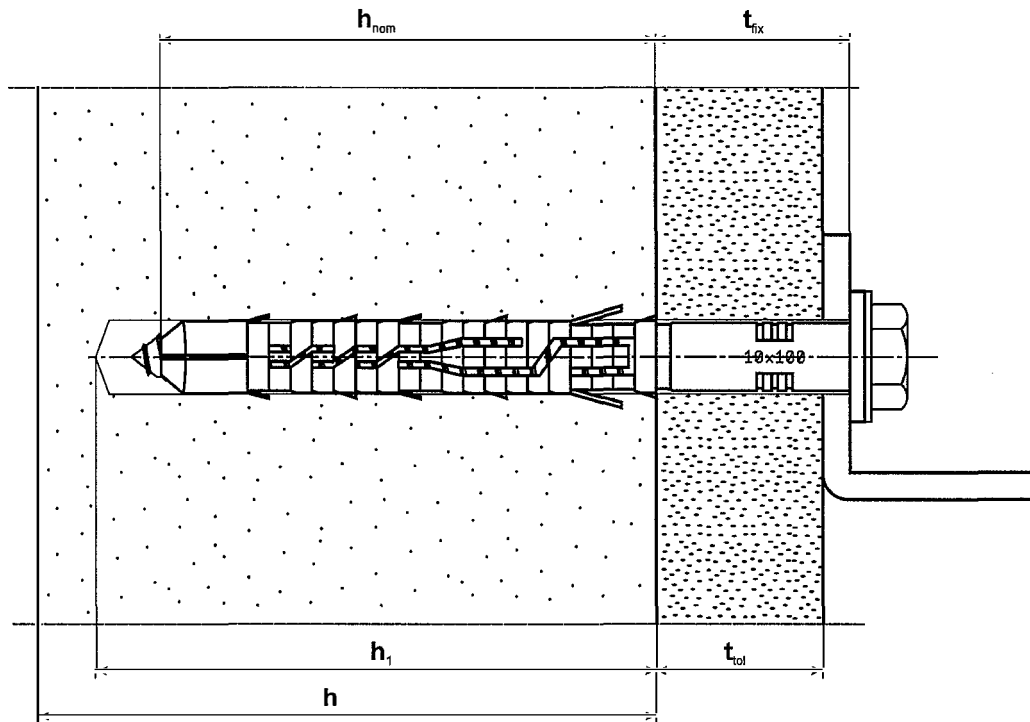

**Intended Use**

Fixing in concrete and in different types of masonry

**Legend**

- $h_{nom}$  = overall plastic anchor embedment depth in the base material
- $h_1$  = depth of drill hole to deepest point
- $h$  = thickness of member (wall)
- $t_{fix}$  =  $t_{tol}$  + thickness of fixture
- $t_{tol}$  = thickness of equalizing layer or non-load-bearing coating

**KPR-FAST, KPS-FAST, KPR/FAST, KPS/FAST,  
KPR-STRONG and KPS-STRONG**

**Product description**  
Intended use

**Annex A1**  
of European  
Technical Assessment  
ETA-12/0272

**Sleeve KPR**

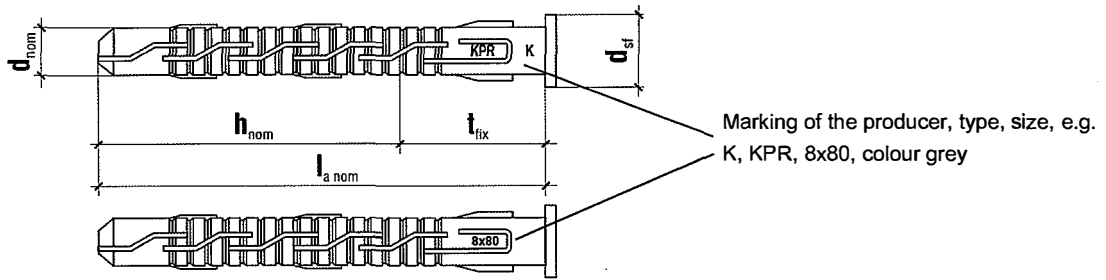

**Screw KS**

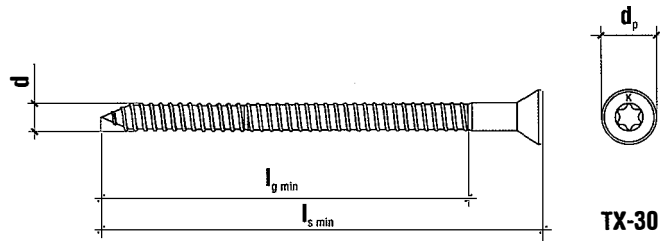

**Screw KK**

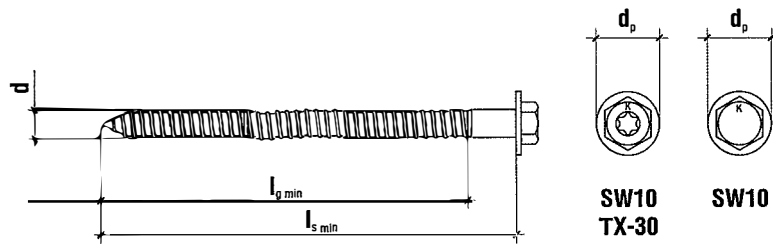

**KPR-FAST, KPS-FAST, KPR/FAST, KPS/FAST,  
KPR-STRONG and KPS-STRONG**

**Product description**  
KPR-FAST 8/50 and 8/70 anchors

**Annex A2**  
of European  
Technical Assessment  
ETA-12/0272

**Sleeve KPS**

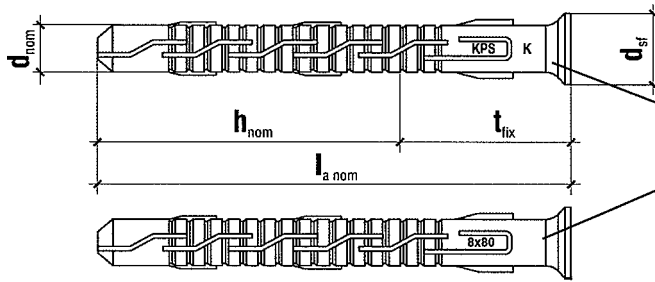

Marking of the producer, type, size, e.g. K, KPS, 8x80, colour grey

**Screw KS**

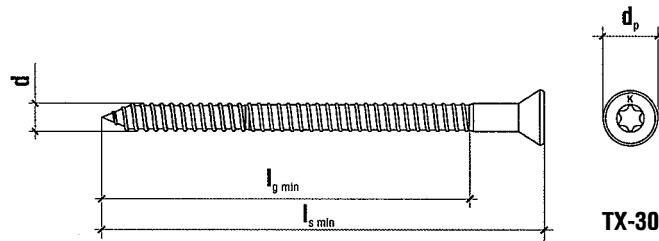

**Screw KK**

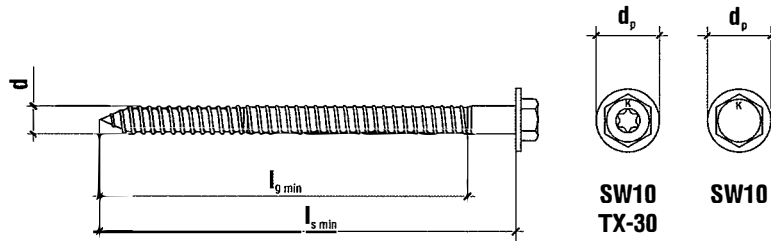

**KPR-FAST, KPS-FAST, KPR/FAST, KPS/FAST, KPR-STRONG and KPS-STRONG**

**Product description**  
KPS-FAST 8/50 and 8/70 anchors

**Annex A3**  
of European  
Technical Assessment  
ETA-12/0272

**Sleeve KPR**

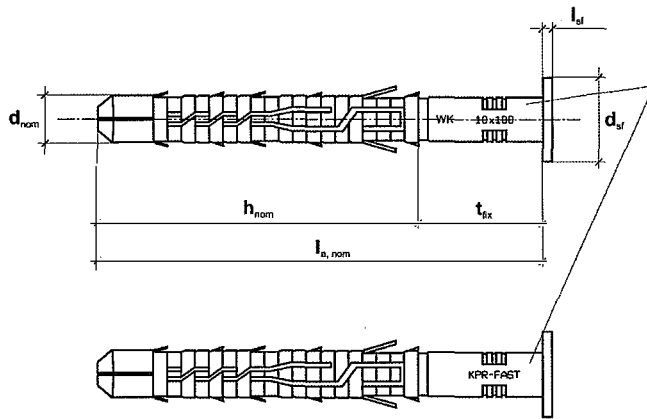

Marking of the producer, type, size, e.g.  
WK, KPR-FAST, 10x100, colour red

**Screw KSS**

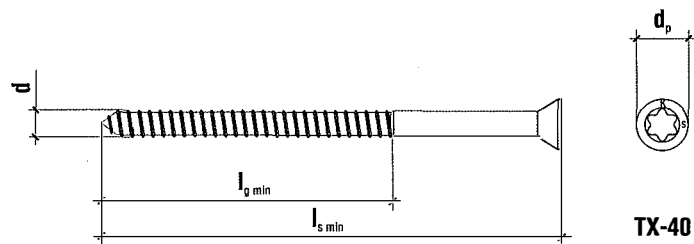

**Screw KKS**

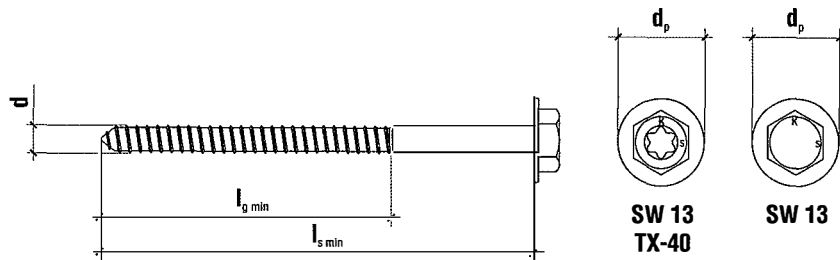

**KPR-FAST, KPS-FAST, KPR/FAST, KPS/FAST,  
KPR-STRONG and KPS-STRONG**

**Product description**  
KPR-STRONG 10 anchors

**Annex A4**  
of European  
Technical Assessment  
ETA-12/0272

**Sleeve KPS**

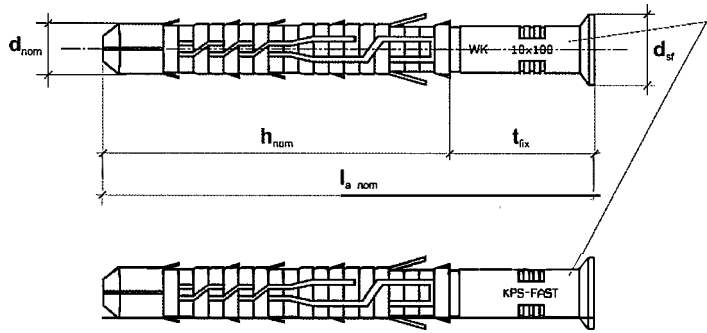

Marking of the producer, type, size, e.g.  
WK, KPS-FAST, 10x100, colour red

**Screw KSS**

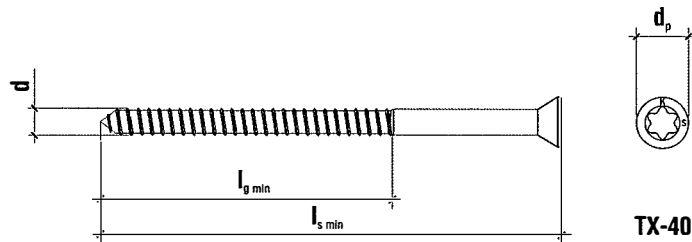

TX-40

**Screw KKS**

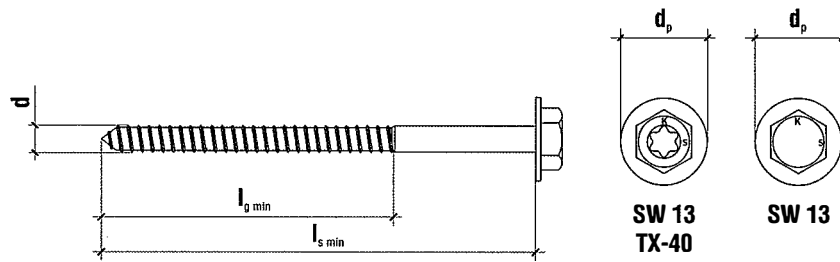

SW 13  
TX-40

SW 13

**KPR-FAST, KPS-FAST, KPR/FAST, KPS/FAST,  
KPR-STRONG and KPS-STRONG**

**Product description**  
KPS-STRONG 10 anchors

**Annex A5**  
of European  
Technical Assessment  
ETA-12/0272



**Sleeve KPR**

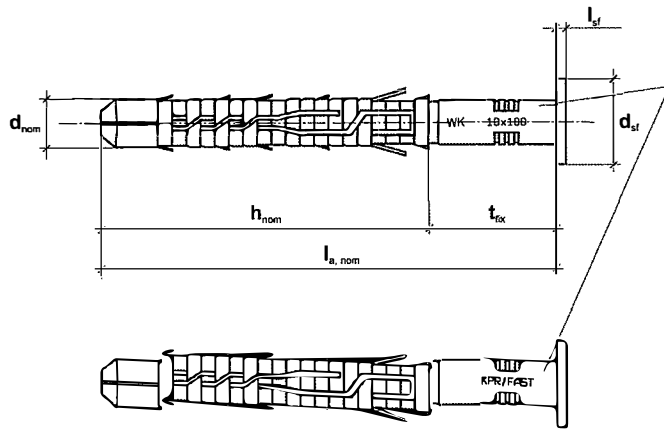

Marking of the producer, type, size, e.g.  
WK, KPR/FAST, 10x100, colour grey

**Screw KS**

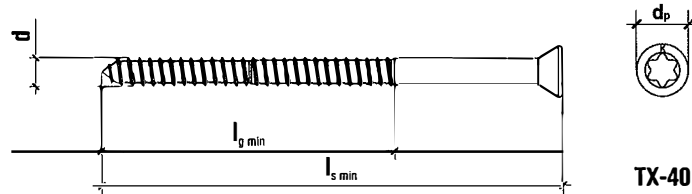

**Screw KK**

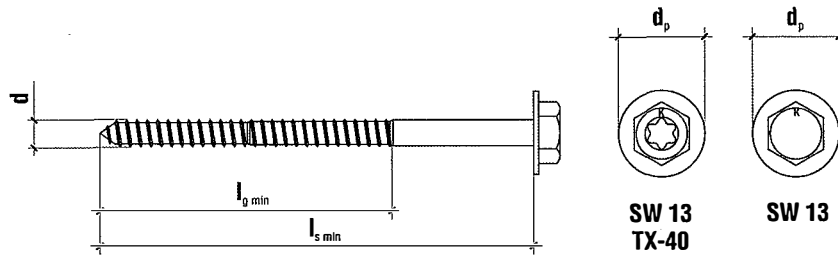

**KPR-FAST, KPS-FAST, KPR/FAST, KPS/FAST,  
KPR-STRONG and KPS-STRONG**

**Product description**  
KPR/FAST 10 anchors

**Annex A6**  
of European  
Technical Assessment  
ETA-12/0272

**Sleeve KPS**

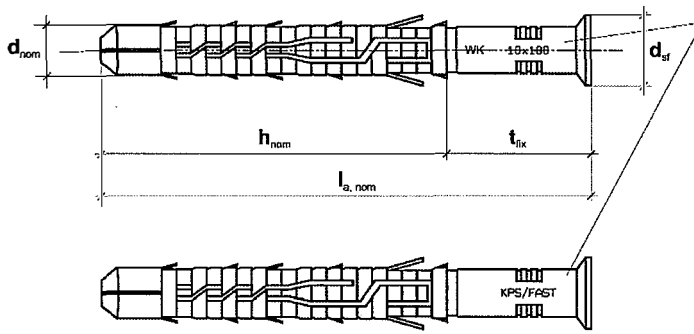

Marking of the producer, type, size, e.g. WK, KPS/FAST, 10x100, colour grey

**Screw KS**

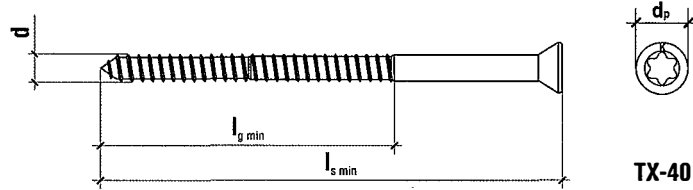

**Screw KK**

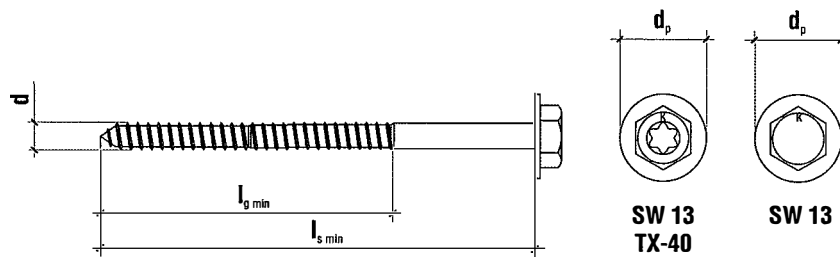

**KPR-FAST, KPS-FAST, KPR/FAST, KPS/FAST, KPR-STRONG and KPS-STRONG**

**Product description**  
KPS/FAST 10 anchors

**Annex A7**  
of European  
Technical Assessment  
ETA-12/0272

**Sleeve KPR**

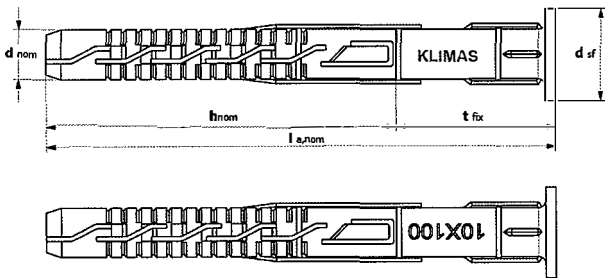

Marking of the producer, type, size, e.g. KLIMAS, KPR-FAST, 10x100, colour grey

**Screw KS**

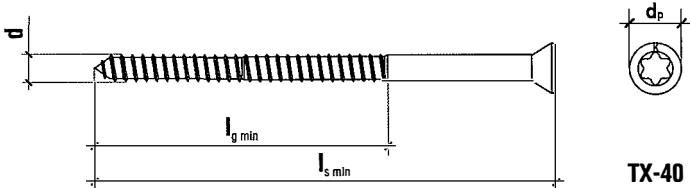

**Screw KK**

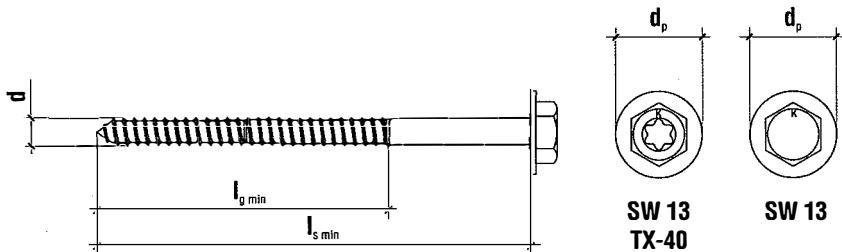

**KPR-FAST, KPS-FAST, KPR/FAST, KPS/FAST, KPR-STRONG and KPS-STRONG**

**Product description**  
KPR-FAST 10/50 and 10/70 anchors

**Annex A8**  
of European  
Technical Assessment  
ETA-12/0272

**Sleeve KPS**

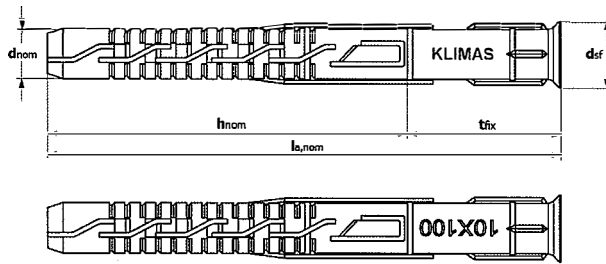

Marking of the producer, type, size, e.g. KLIMAS, KPS-FAST, 10x100, colour grey

**Šruba KS**

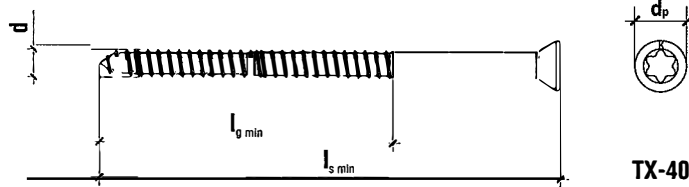

**Šruba KK**

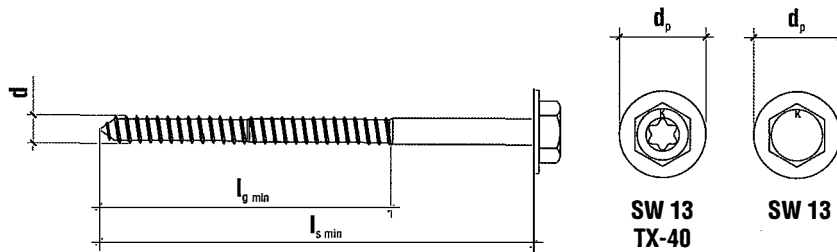

**KPR-FAST, KPS-FAST, KPR/FAST, KPS/FAST, KPR-STRONG and KPS-STRONG**

**Product description**  
KPS-FAST 10/50 and 10/70 anchors

**Annex A9**  
of European  
Technical Assessment  
ETA-12/0272

**Sleeve KPR**

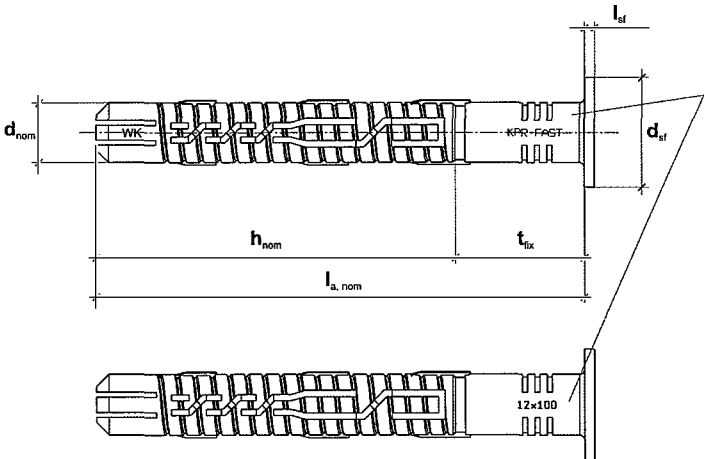

Marking of the producer, type, size, e.g.  
WK, KPR-FAST, 12x100, colour grey

**Screw KS**

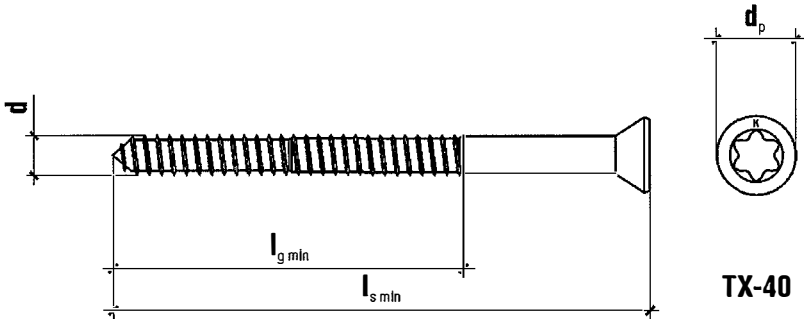

**TX-40**

**Screw KK**

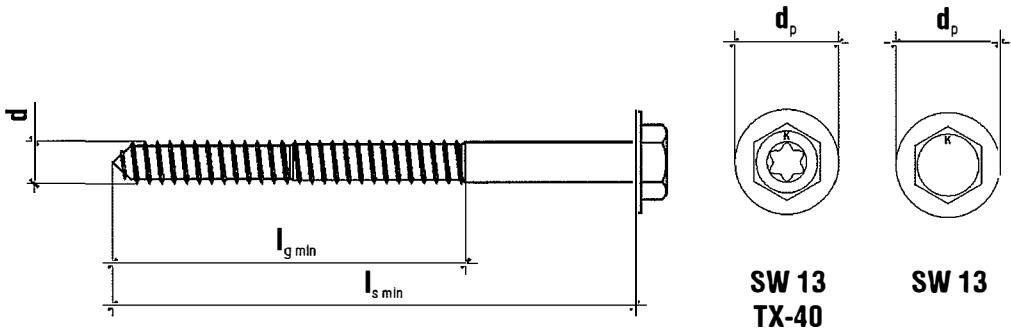

**SW 13  
TX-40**

**SW 13**

**KPR-FAST, KPS-FAST, KPR/FAST, KPS/FAST,  
KPR-STRONG and KPS-STRONG**

**Product description  
KPR-FAST 12 anchors**

**Annex A10  
of European  
Technical Assessment  
ETA-12/0272**

**Sleeve KPS**

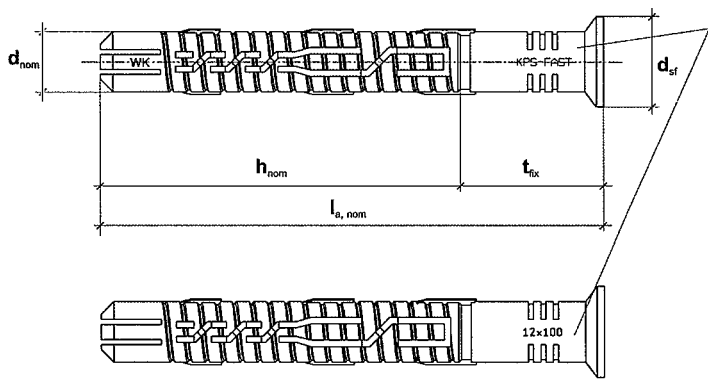

Marking of the producer, type, size, e.g.  
WK, KPS-FAST, 12x100, colour grey

**Screw KS**

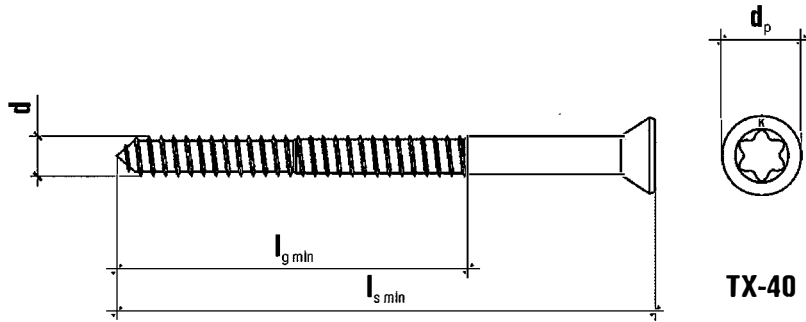

**Screw KK**

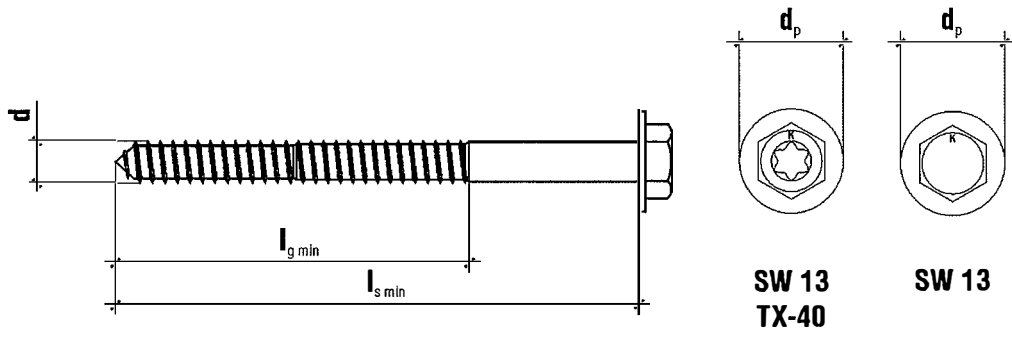

**KPR-FAST, KPS-FAST, KPR/FAST, KPS/FAST,  
KPR-STRONG and KPS-STRONG**

**Product description**  
KPS-FAST 12 anchors

**Annex A11**  
of European  
Technical Assessment  
ETA-12/0272

**Sleeve KPR**

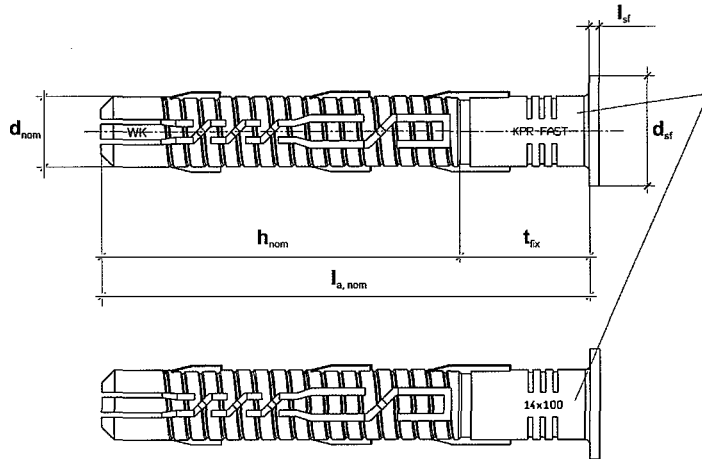

Marking of the producer, type, size, e.g.  
WK, KPR-FAST, 14x100, colour grey

**Screw KS**

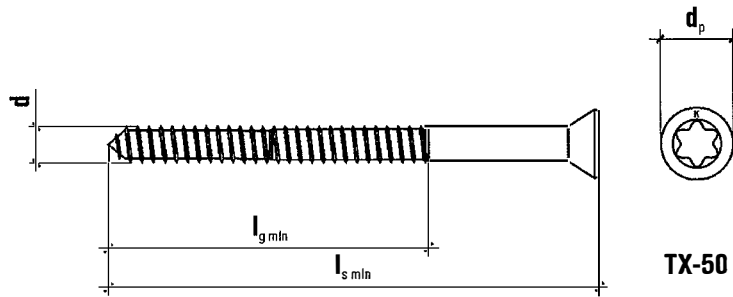

**Screw KK**

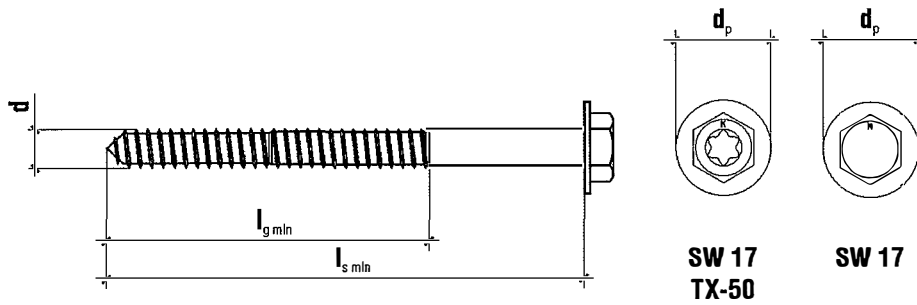

**KPR-FAST, KPS-FAST, KPR/FAST, KPS/FAST,  
KPR-STRONG and KPS-STRONG**

**Product description**  
KPR-FAST 14 anchors

**Annex A12**  
of European  
Technical Assessment  
ETA-12/0272

**Sleeve KPS**

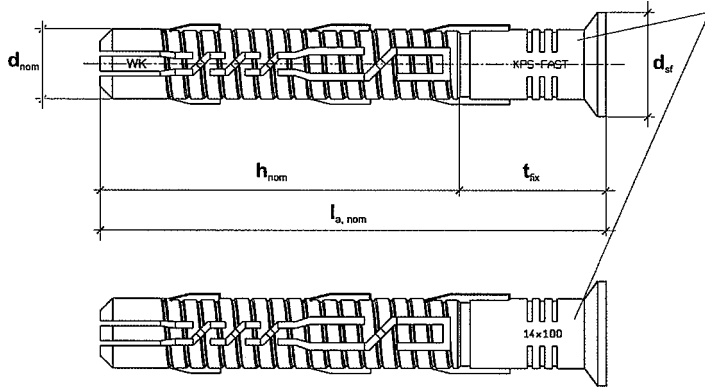

Marking of the producer, type, size, e.g.  
WK, KPS-FAST, 14x100, colour grey

**Screw KS**

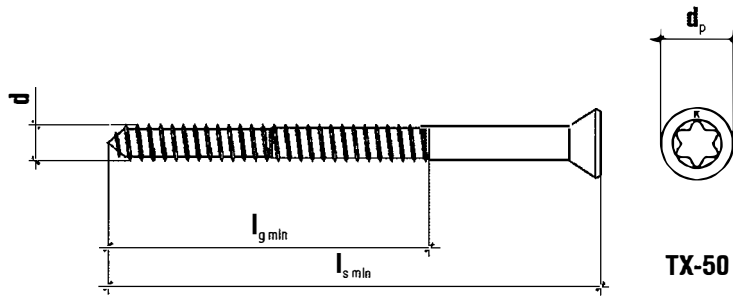

**Screw KK**

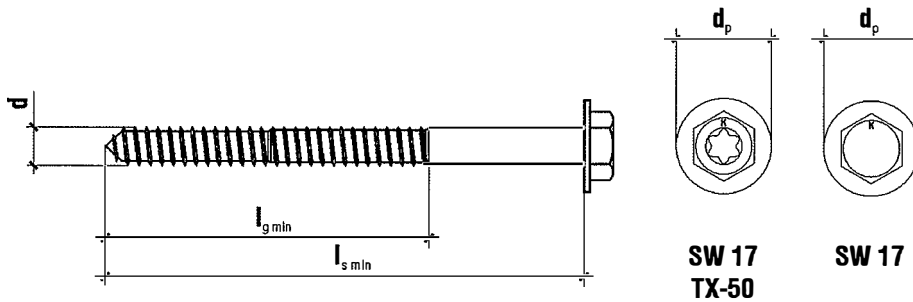

**KPR-FAST, KPS-FAST, KPR/FAST, KPS/FAST,  
KPR-STRONG and KPS-STRONG**

**Product description**  
KPS-FAST 14 anchors

**Annex A13**  
of European  
Technical Assessment  
ETA-12/0272



# Appendix 16/37

**Table A1: Anchor types and dimensions**

Anchor type	Anchor sleeve <sup>1)</sup>					Screw <sup>1)</sup>				
	d <sub>nom</sub> [mm]	d <sub>sf</sub> [mm]	h <sub>nom</sub> [mm]	l <sub>a, nom</sub> [mm]	l <sub>sf</sub> [mm]	d [mm]	l <sub>g, min</sub> [mm]	l <sub>s, min</sub> [mm]	d <sub>p</sub> [mm]	
									KK KKS <sup>2)</sup>	KS KSS <sup>2)</sup>
KPR-FAST 8/50	8	15	50	60 - 220	2	6.0	50	l <sub>a, nom</sub> + 5 mm	13	11
KPS-FAST 8/50	8	12	50	60 - 220	-	6.0	50	l <sub>a, nom</sub> + 5 mm	13	11
KPR-FAST 8/70	8	15	70	80 - 220	2	6.0	70	l <sub>a, nom</sub> + 5 mm	13	11
KPS-FAST 8/70	8	12	70	80 - 220	-	6.0	70	l <sub>a, nom</sub> + 5 mm	13	11
KPR-STRONG 10 <sup>2)</sup>	10	18	70	80 - 300	2	7.0	65	l <sub>a, nom</sub> + 5 mm	18 <sup>2)</sup>	14 <sup>2)</sup>
KPS-STRONG 10 <sup>2)</sup>	10	15	70	80 - 300	-	7.0	65	l <sub>a, nom</sub> + 5 mm	18 <sup>2)</sup>	14 <sup>2)</sup>
KPR/FAST 10	10	18	70	80 - 300	2	7.0	65	l <sub>a, nom</sub> + 5 mm	18	14
KPS/FAST 10	10	15	70	80 - 300	-	7.0	65	l <sub>a, nom</sub> + 5 mm	18	14
KPR-FAST 10/50	10	18	50	60 - 300	2	7.0	50	l <sub>a, nom</sub> + 5 mm	18	14
KPS-FAST 10/50	10	13	50	60 - 300	-	7.0	50	l <sub>a, nom</sub> + 5 mm	18	14
KPR-FAST 10/50	10	18	70	80 - 300	2	7.0	70	l <sub>a, nom</sub> + 5 mm	18	14
KPS-FAST 10/50	10	13	70	80 - 300	-	7.0	70	l <sub>a, nom</sub> + 5 mm	18	14
KPR-FAST 12	12	18	70	80 - 360	2	8.0	70	l <sub>a, nom</sub> + 5 mm	18	14
KPS-FAST 12	12	15	70	80 - 360	-	8.0	70	l <sub>a, nom</sub> + 5 mm	18	14
KPR-FAST 14	14	22	70	80 - 360	2	10.0	60	l <sub>a, nom</sub> + 10 mm	22	20
KPS-FAST 14	14	22	70	80 - 360	-	10.0	60	l <sub>a, nom</sub> + 10 mm	22	20

<sup>1)</sup> the anchor (plastic sleeve and special screw) shall only be packaged and supplied as a complete unit

<sup>2)</sup> with special screw KKS and KSS

**KPR-FAST, KPS-FAST, KPR/FAST, KPS/FAST,  
KPR-STRONG and KPS-STRONG**

**Product description**  
Anchor types and dimensions

**Annex A14**  
of European  
Technical Assessment  
ETA-12/0272

# Appendix 17/37

<b>Table A2: Materials</b>			
Element	Material		
	KPR-FAST 8 KPS-FAST 8  KPR/FAST 10 KPS/FAST 10  KPR-FAST 10 KPS-FAST 10	KPR-STRONG 10 KPS-STRONG 10	KPR-FAST 12 KPS-FAST 12  KPR-FAST 14 KPS-FAST 14
Anchor sleeve	polyamid, PA6, colour grey	polyamid, PA6, colour red	polyamid, PA6, colour grey
Specific screw	steel ( $f_{y,k} \geq 480$ MPa, $f_{u,k} \geq 600$ MPa)		steel ( $f_{y,k} \geq 320$ MPa, $f_{u,k} \geq 400$ MPa)
	a) electroplated coating $\geq 5 \mu\text{m}$ according to EN ISO 4042 or non-electrolytically applied zinc flake coating $\geq 5 \mu\text{m}$ according to EN ISO 10683; b) hot dip galvanised coating $\geq 40 \mu\text{m}$ according to EN ISO 10684; c) "SQ-ceramic" non-electrolytically applied zinc flake coating $\geq 10 \mu\text{m}$ according to EN ISO 10683; d) zinc diffusion coating $\geq 30 \mu\text{m}$ according to EN 13811 and EN ISO 17668		
	or stainless steel grade 1.4301, 1.4306, 1.4307, 1.4567 (AISI 304) or 1.4401, 1.4404, 1.4571, 1.4362, 1.4578 (AISI 316) according to EN 10088 ( $f_{y,k} \geq 450$ MPa, $f_{u,k} \geq 580$ MPa)		
<b>KPR-FAST, KPS-FAST, KPR/FAST, KPS/FAST, KPR-STRONG and KPS-STRONG</b>			<b>Annex A15</b>  of European Technical Assessment ETA-12/0272
<b>Product description</b> Materials			

# Appendix 18/37

## Specification of intended use

### Anchorage subject to:

- Static and quasi-static loads.
- Multiple fixing of non-structural applications.

### Base materials:

- Reinforced or unreinforced normal weight concrete with strength classes  $\geq$  C12/15 (base material group a), according to EN 206.
- Thin-wall concrete elements, reinforced or unreinforced, with strength classes  $\geq$  C16/20 and wall thickness  $\geq$  30 mm (base material group a).
- Solid masonry (base material group b), according to Annex C3.  
Note: The characteristic resistance is also valid for larger sizes and larger compressive strength of the masonry unit.
- Hollow or perforated masonry (base material group c), according to Annex C3.
- Autoclaved aerated concrete (base material group d), according to Annex C3.
- Mortar strength class of the masonry M2.5 at minimum according to EN 998-2.
- For other base materials of the base material group a, b, c and d the characteristic resistance of the anchor may be determined by job site tests according to TR 051:2018-04.

### Temperature range:

- -20°C to +80°C (max. short term temperature +80°C and max. long term temperature +50°C).

### Use conditions (environmental conditions):

- Structures subject to dry internal conditions (zinc coated steel, stainless steel).
- Structures subject to external atmospheric exposure, if anchor is not directly subjected to this exposure, i.e. external cladding elements screen the anchor, and the head of screw is additionally protected by permanently elastic coating which precludes corrosion from occurring and prevents moisture from entering into plastic sleeve (zinc coated steel).
- Structures subject to external atmospheric exposure including industrial and marine environment (stainless steel).
- Structures subject to permanently damp internal condition, if no particular aggressive conditions exist (stainless steel).

Note: Particular aggressive conditions are e.g. permanent, alternating immersion in seawater or the splash zone of seawater, chloride atmosphere of indoor swimming pools or atmosphere with extreme chemical pollution (e.g. in desulphurization plants or road tunnels where de-icing materials are used).

### Design:

- The anchorages are designed in accordance with the TR 064:2018-05 under the responsibility of an engineer experienced in anchorages and masonry work.
- Verifiable calculation notes and drawings shall be prepared taking account the loads to be anchored, the nature and strength of the base materials and the dimensions of the anchorage members as well as of the relevant tolerances. The position of the anchor is indicated on the design drawings.
- Anchors are only to be used for multiple fixings for non-structural application, according to TR 064:2018-05.

### Installation:

- Hole shall be drilled by the drill modes given in Annexes C2 and C3 for use categories a, b, c and d; the influence of other drilling methods may be determined by job site tests according to TR 051:2018-04.
- Anchor installation shall be carried out by appropriately qualified personnel and under the supervision of the person responsible for technical matters of the site.
- Installation shall be executed in temperature from -20°C to +40°C.
- Exposure to UV due to solar radiation of the anchor not protected by the mortar shall not exceed  $\leq$  6 weeks.

**KPR-FAST, KPS-FAST, KPR/FAST, KPS/FAST,  
KPR-STRONG and KPS-STRONG**

**Intended use  
Specifications**

**Annex B1  
of European  
Technical Assessment  
ETA-12/0272**

# Appendix 19/37

**Table B1: Installation parameters**

Anchor type		KPR-FAST 8/50 KPS-FAST 8/50	KPR-FAST 8/70 KPS-FAST 8/70	KPR/FAST 10 KPS/FAST 10 KPR-FAST 10/70 KPS-FAST 10/70 KPR-STRONG 10 KPS-STRONG 10	KPR-FAST 10/50 KPS-FAST 10/50	KPR-FAST 12 KPS-FAST 12	KPR-FAST 14 KPS-FAST 14
Drill hole diameter	$d_o$ [mm]	8	8	10	10	12	14
Cutting diameter of drill bit	$d_{cur. \leq}$ [mm]	8.45	8.45	10.45	10.45	12.45	14.45
Depth of drill hole to deepest point	$h_1 \geq$ [mm]	60	80	80	60	80	85
Overall plastic anchor embedment depth in the base material	$h_{nom} \geq$ [mm]	50	70	70	50	70	70
Diameter of clearance hole in the fixture	$d_f \leq$ [mm]	8.5 - 9.0	8.5 - 9.0	10.5 - 11.0	10.5 - 11.0	12.5 - 13.0	14.5 - 15.0
Thickness of fixture – minimum	$t_{fix, min} \geq$ [mm]	1	1	1	1	1	1
Thickness of fixture – maximum	$t_{fix, max} \leq$ [mm]	170	150	230	250	290	290
Installation temperature	°C	-20 to +40					
Torque moment for concrete and masonry	$T_{inst}$ [Nm]	7	7	15	15	30	50
Torque moment for AAC	$T_{inst}$ [Nm]	3	3	5	5	13	18

**KPR-FAST, KPS-FAST, KPR/FAST, KPS/FAST,  
KPR-STRONG and KPS-STRONG**

**Intended use**  
Installation parameters

**Annex B2**  
of European  
Technical Assessment  
ETA-12/0272

# Appendix 20/37

**Table B2: Minimum thickness of member, edge distance and spacing in concrete**

Anchor type	Base material	$h_{min}$ [mm]	$C_{cr, N}$ [mm]	$S_{cr, N}$ [mm]	$C_{min}$ [mm]	$S_{min}$ [mm]
KPR-FAST 8/50 KPS-FAST 8/50	Concrete $\geq$ C16/20	100	70	70	50	50
	Concrete $\geq$ C12/15	100	100	95	70	70
KPR-FAST 8/70 KPS-FAST 8/70	Concrete $\geq$ C16/20	100	100	80	60	60
	Concrete $\geq$ C12/15	100	140	115	80	80
KPR/FAST 10 KPS/FAST 10	Concrete $\geq$ C16/20	100	100	75	60	60
	Concrete $\geq$ C12/15	100	140	105	80	80
KPR-FAST10/50 KPS-FAST10/50	Concrete $\geq$ C16/20	100	100	75	50 for $s \geq 150$ mm	50 for $c \geq 100$ mm
	Concrete $\geq$ C12/15	100	140	105	70 for $s \geq 210$ mm	70 for $c \geq 140$ mm
	Thin wall concrete elements $\geq$ C16/20	30	100	100	100	100
KPR-FAST10/70 KPS-FAST10/70	Concrete $\geq$ C16/20	100	100	110	50 for $s \geq 150$ mm	50 for $c \geq 100$ mm
	Concrete $\geq$ C12/15	100	140	150	70 for $s \geq 210$ mm	70 for $c \geq 150$ mm
	Thin wall concrete elements $\geq$ C16/20	30	100	100	100	100
KPR-FAST 12 KPS-FAST 12	Concrete $\geq$ C16/20	100	100	85	100	100
	Concrete $\geq$ C12/15	100	140	120	140	140
KPR-FAST 14 KPS-FAST 14	Concrete $\geq$ C16/20	100	100	115	100	100
	Concrete $\geq$ C12/15	100	140	160	140	140

**KPR-FAST, KPS-FAST, KPR/FAST, KPS/FAST,  
KPR-STRONG and KPS-STRONG**

**Intended use**  
Minimum thickness of member, edge distance and spacing in concrete

**Annex B3**  
of European  
Technical Assessment  
ETA-12/0272

**Scheme of edge distance and spacing in concrete**

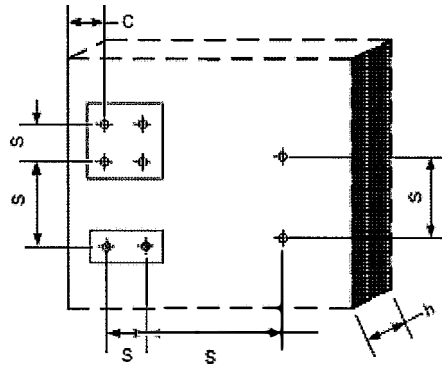

**Scheme of edge distance and spacing in thin-wall concrete elements**

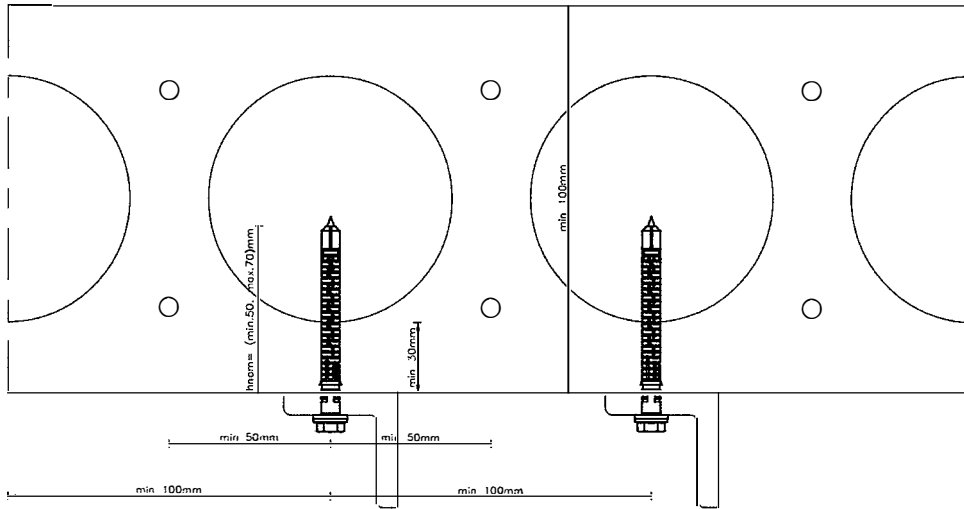

**KPR-FAST, KPS-FAST, KPR/FAST, KPS/FAST,  
KPR-STRONG and KPS-STRONG**

**Intended use**  
Minimum thickness of member, edge distance and spacing in concrete

**Annex B3**  
of European  
Technical Assessment  
ETA-12/0272

**Table B3: Minimum thickness of member, edge distance and spacing in masonry**

Anchor diameter	Base material	Type of element	Single anchor			Anchor group <sup>1)</sup>	
			$h_{min}$ [mm]	$C_{min}$ [mm]	$S_{min}$ [mm]	$S_{min1}$ <sup>2)</sup> [mm]	$S_{min2}$ <sup>3)</sup> [mm]
φ8	masonry made of ceramic, calcium silicate and lightweight aggregate concrete elements	solid	120	100	100	100	200
		perforated or hollow	180	100	100	100	200
	masonry made of autoclaved aerated concrete elements	–	100	100	100	100	200
φ10	masonry made of ceramic, calcium silicate and lightweight aggregate concrete elements	solid	120	100	100	100	200
		perforated or hollow	180	100	100	100	200
	masonry made of autoclaved aerated concrete elements	–	100	100	100	100	200
φ12	masonry made of ceramic, calcium silicate and lightweight aggregate concrete elements	solid	120	100	100	100	200
		perforated or hollow	180	100	100	100	200
	masonry made of autoclaved aerated concrete elements	–	100	100	100	100	200
φ14	masonry made of ceramic, calcium silicate and lightweight aggregate concrete elements	solid	120	100	100	100	200
		perforated or hollow	180	100	100	100	200
	masonry made of autoclaved aerated concrete elements	–	100	100	100	100	200

<sup>1)</sup> the design method valid for single anchor and anchor groups with two or four anchors  
<sup>2)</sup> in direction perpendicular to free edge  
<sup>3)</sup> in direction parallel to free edge

**Scheme of edge distance and spacing in masonry**

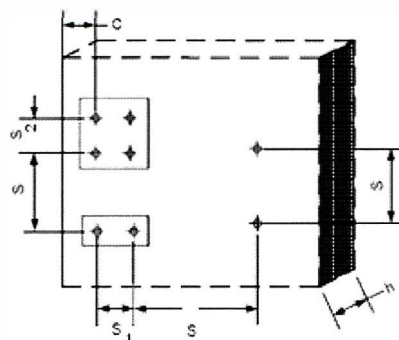

**KPR-FAST, KPS-FAST, KPR/FAST, KPS/FAST, KPR-STRONG and KPS-STRONG**

**Intended use**  
 Minimum thickness of member, edge distance and spacing in masonry

**Annex B4**  
 of European  
 Technical Assessment  
 ETA-12/0272

# Appendix 23/37

	<p>Drill the hole considering the drilling method and clean the hole of drilling dust.</p>
	<p>Insert the plastic sleeve and special screw into the hole through the fixture by slight hammer blows.</p>
	<p>Screw-in the special screw until the head of the screw touches the sleeve; the anchor is correct mounted, if there is no turn-through of the plastic sleeve in the drill hole and if slightly move on turning of the screw is impossible.</p>
<p><b>KPR-FAST, KPS-FAST, KPR/FAST, KPS/FAST, KPR-STRONG and KPS-STRONG</b></p>	<p><b>Annex B5</b> of European Technical Assessment ETA-12/0272</p>
<p><b>Intended use</b> Installation instruction</p>	



**Table C1.1: Characteristic bending resistance of the specific screw in concrete and masonry**

Anchor diameter		φ8	φ10	φ12	φ14
Characteristic bending resistance	$M_{Rk,s}$ [Nm]	10.5 <sup>1)</sup> (10.2) <sup>2)</sup>	16.8 <sup>1)</sup> (16.3) <sup>2)</sup>	16.2 <sup>1)</sup> (23.4) <sup>2)</sup>	34.4 <sup>1)</sup> (49.8) <sup>2)</sup>
Partial safety factor	$\gamma_{Ms}$ <sup>3)</sup>	1.25 <sup>1)</sup> / 1.29 <sup>2)</sup>	1.25 <sup>1)</sup> / 1.29 <sup>2)</sup>	1.25 <sup>1)</sup> / 1.29 <sup>2)</sup>	1.25 <sup>1)</sup> / 1.29 <sup>2)</sup>
<sup>1)</sup> galvanised steel <sup>2)</sup> stainless steel <sup>3)</sup> in the absence of other national regulations					

**Table C1.2: Characteristic resistance of the screw for use in concrete – failure of expansion element (specific screw)**

Anchor diameter		φ8	φ10	φ12	φ14
Characteristic tension resistance	$N_{Rk,s}$ [kN]	13.2 <sup>1)</sup> (12.8) <sup>2)</sup>	18.1 <sup>1)</sup> (17.5) <sup>2)</sup>	15.4 <sup>1)</sup> (22.3) <sup>2)</sup>	25.4 <sup>1)</sup> (36.9) <sup>2)</sup>
Partial safety factor	$\gamma_{Ms}$ <sup>3)</sup>	1.50 <sup>1)</sup> / 1.55 <sup>2)</sup>	1.50 <sup>1)</sup> / 1.55 <sup>2)</sup>	1.50 <sup>1)</sup> / 1.55 <sup>2)</sup>	1.50 <sup>1)</sup> / 1.55 <sup>2)</sup>
Characteristic shear resistance	$V_{Rk,s}$ [kN]	6.6 <sup>1)</sup> (6.4) <sup>2)</sup>	9.1 <sup>1)</sup> (8.8) <sup>2)</sup>	7.70 <sup>1)</sup> (11.2) <sup>2)</sup>	12.7 <sup>1)</sup> (18.4) <sup>2)</sup>
Partial safety factor	$\gamma_{Ms}$ <sup>3)</sup>	1.25 <sup>1)</sup> / 1.29 <sup>2)</sup>	1.25 <sup>1)</sup> / 1.29 <sup>2)</sup>	1.25 <sup>1)</sup> / 1.29 <sup>2)</sup>	1.25 <sup>1)</sup> / 1.29 <sup>2)</sup>
<sup>1)</sup> galvanised steel <sup>2)</sup> stainless steel <sup>3)</sup> in the absence of other national regulations					

**KPR-FAST, KPS-FAST, KPR/FAST, KPS/FAST,  
KPR-STRONG and KPS-STRONG**

**Performances**  
Characteristic resistance of the screw

**Annex C1**  
of European  
Technical Assessment  
ETA-12/0272

**Table C2.1: Characteristic resistance for use in concrete, pull-out failure (plastic sleeve); hammer drilling**

Anchor type	KPR-FAST 8/50 KPS-FAST 8/50	KPR-FAST 8/70 KPS-FAST 8/70	KPR/FAST 10 KPS/FAST 10	KPR-FAST 10/50 KPS-FAST 10/50	KPR-FAST 10/70 KPS-FAST 10/70	KPR-STRONG 10 KPS-STRONG 10	KPR-FAST 12 KPS-FAST 12	KPR-FAST 14 KPS-FAST 14
Temperature range [°C]	-20 to +80							
<b>Concrete ≥ C16/20</b>								
Characteristic resistance $N_{Rk,p}$ [kN]	3.5	4.5	4.0	4.0	8.5	6.0	5.0	7.5
Partial safety factor $\gamma_{Mc}$ <sup>1)</sup>	1.8							
<b>Concrete C12/15</b>								
Characteristic resistance $N_{Rk,p}$ [kN]	2.5	3.0	3.0	3.0	6.0	4.5	3.5	5.0
Partial safety factor $\gamma_{Mc}$ <sup>1)</sup>	1.8							
<b>Thin-wall concrete elements C16/20, h ≥ 30 mm</b>								
Characteristic resistance $N_{Rk,p}$ [kN]	-	-	-	4.0	4.0	-	-	-
Partial safety factor $\gamma_{Mc}$ <sup>1)</sup>	1.8							
<sup>1)</sup> in the absence of other national regulations								

**KPR-FAST, KPS-FAST, KPR/FAST, KPS/FAST,  
KPR-STRONG and KPS-STRONG**

**Performances**  
Characteristic resistance in concrete (base material group a)

**Annex C2**  
of European  
Technical Assessment  
ETA-12/0272

# Appendix 26/37

**Table C3.1: Displacements under tension and shear loading in concrete <sup>1), 2)</sup>**

Anchor type	Tension load			Shear load		
	F [kN]	$\delta_{NO}$ [mm]	$\delta_{N=}$ [mm]	F [kN]	$\delta_{NO}$ [mm]	$\delta_{N=}$ [mm]
KPR-FAST 8/50 KPS-FAST 8/50	1.4	0.34	0.68	3.7	3.16	4.74
KPR-FAST 8/70 KPS-FAST 8/70	1.78	0.29	0.58	3.7	3.16	4.74
KPR/FAST 10 KPS/FAST 10	1.6	0.26	0.73	7.2	3.6	5.39
KPR-FAST 10 KPS-FAST 10 STRONG	2.38	0.35	0.7	7.2	3.6	5.39
KPR-FAST 12 KPS-FAST 12	1.98	0.37	0.55	8.29	3.83	5.74
KPR-FAST 14 KPS-FAST 14	3.0	0.31	0.86	12.91	5.77	8.65
KPR-FAST 10/50 KPS-FAST 10/50	1.6	0.3	0.6	7.2	3.6	5.39
KPR-FAST 10/70 KPS-FAST 10/70	3.37	0.3	0.6	7.2	3.6	5.39

<sup>1)</sup> valid for all ranges of temperatures

<sup>2)</sup> intermediate values by linear interpolation

**Table C3.2: Characteristic values  $F_{Rk}$  in any load direction under fire exposure in concrete C20/25 to C50/60, no permanent centric tension load and shear load with lever arm, for fixing of façade systems**

Anchor type	Fire resistance class	$F_{Rk}$ , kN
KPR/FAST 10, KPRS/FAST 10 KPR-STRONG 10, KPS-STRONG 10 KPR-FAST 10, KPS-FAST 10	R 90	0.8

**KPR-FAST, KPS-FAST, KPR/FAST, KPS/FAST,  
KPR-STRONG and KPS-STRONG**







**Performances**

Characteristic resistance in concrete (base material group a),  
displacements in concrete, resistance to fire

**Annex C3**  
of European  
Technical Assessment  
ETA-12/0272

# Appendix 27/37

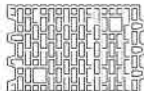
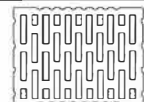
**Table C4.1: Characteristic resistance for use in masonry**

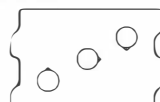
Anchor type / Base material	Bulk density class [kg/dm <sup>3</sup> ]	Mean compressive strength class [N/mm <sup>2</sup> ]	Picture	Drill method	F <sub>Rk</sub> <sup>16)</sup> [kN]
<b>KPR-FAST 8/50 and KPS-FAST 8/50</b>					
Clay brick <sup>1), 6)</sup>	≥ 2.00	≥ 10		hammer	3.0
Clay brick <sup>1), 6)</sup>	≥ 2.00	≥ 20		hammer	3.0
Calcium silicate brick <sup>2), 7)</sup>	≥ 2.00	≥ 20		hammer	3.0
<b>KPR-FAST 8/70 and KPS-FAST 8/70</b>					
Clay brick <sup>1), 6)</sup>	≥ 2.00	≥ 10		hammer	2.5
Clay brick <sup>1), 6)</sup>	≥ 2.00	≥ 20		hammer	3.0
Calcium silicate brick <sup>2), 7)</sup>	≥ 2.00	≥ 20		hammer	3.0
Perforated ceramic brick <sup>1), 9)</sup>	≥ 0.80	≥ 15		rotary drilling only	1.2
Perforated ceramic brick <sup>1), 10)</sup>	≥ 0.80	≥ 15		rotary drilling only	1.2
Calcium silicate hollow block <sup>2), 12)</sup>	≥ 1.60	≥ 12		rotary drilling only	2.5
Hollow lightweight aggregate concrete element <sup>3), 13)</sup>	≥ 0.80	≥ 2		rotary drilling only	2.0
Autoclaved aerated concrete element AAC 2 <sup>4)</sup>	≥ 0.35	≥ 2	–	rotary drilling only	0.6
Autoclaved aerated concrete element AAC 7 <sup>4)</sup>	≥ 0.65	≥ 6.5	–	rotary drilling only	2.0

**KPR-FAST, KPS-FAST, KPR/FAST, KPS/FAST, KPR-STRONG and KPS-STRONG**









**Performances**

Characteristic resistance in masonry (base material group b, c and d)

**Annex C4**  
of European  
Technical Assessment  
ETA-12/0272

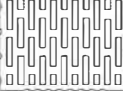
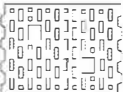
# Appendix 28/37

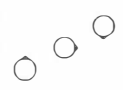
## extension of Table C4.1

Anchor type / Base material	Bulk density class [kg/dm <sup>3</sup> ]	Mean compressive strength class [N/mm <sup>2</sup> ]	Picture	Drill method	F <sub>rk</sub> <sup>16)</sup> [kN]
<b>KPR/FAST 10 and KPS/FAST 10</b>					
Clay brick <sup>1), 5)</sup>	≥ 1.70	≥ 10		hammer	3.5
Clay brick <sup>1), 5)</sup>	≥ 1.70	≥ 20		hammer	3.5
Clay brick <sup>1), 6)</sup>	≥ 2.00	≥ 10		hammer	3.5
Clay brick <sup>1), 6)</sup>	≥ 2.00	≥ 20		hammer	3.5
Calcium silicate brick <sup>2), 7)</sup>	≥ 2.00	≥ 20		hammer	3.5
Perforated ceramic brick <sup>1), 9)</sup>	≥ 0.80	≥ 15		rotary drilling only	0.9
Perforated ceramic brick <sup>1), 10)</sup>	≥ 0.80	≥ 15		rotary drilling only	0.9
Perforated ceramic brick <sup>1), 11)</sup>	≥ 1.20	≥ 12		rotary drilling only	2.0
Calcium silicate hollow block <sup>2), 12)</sup>	≥ 1.60	≥ 12		rotary drilling only	2.5
Hollow lightweight aggregate concrete element <sup>3), 13)</sup>	≥ 0.80	≥ 2		rotary drilling only	2.0
Autoclaved aerated concrete element AAC 2 <sup>4)</sup>	≥ 0.35	≥ 2	-	rotary drilling only	0.6
Autoclaved aerated concrete element AAC 7 <sup>4)</sup>	≥ 0.65	≥ 6.5	-	rotary drilling only	1.5
<b>KPR-STRONG 10 and KPS-STRONG 10</b>					
Clay brick <sup>1), 6)</sup>	≥ 2.00	≥ 10		hammer	3.5
Clay brick <sup>1), 6)</sup>	≥ 2.00	≥ 20		hammer	3.5
Calcium silicate brick <sup>2), 7)</sup>	≥ 2.00	≥ 20		hammer	3.5







**KPR-FAST, KPS-FAST, KPR/FAST, KPS/FAST,  
KPR-STRONG and KPS-STRONG**

**Performances**  
Characteristic resistance in masonry (base material group b, c and d)

**Annex C4**  
of European  
Technical Assessment  
ETA-12/0272

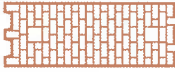
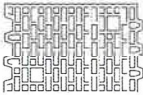
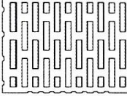
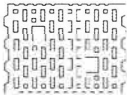
# Appendix 29/37

## extension of Table C4.1

Anchor type / Base material	Bulk density class [kg/dm <sup>3</sup> ]	Mean compressive strength class [N/mm <sup>2</sup> ]	Picture	Drill method	F <sub>Rk</sub> <sup>16)</sup> [kN]
<b>KPR-FAST 10/50 and KPS-FAST 10/50</b>					
Clay brick <sup>1), 5)</sup>	≥ 1.70	≥ 10		hammer	1.5
Clay brick <sup>1), 5)</sup>	≥ 1.70	≥ 20		hammer	2.0
Clay brick <sup>1), 6)</sup>	≥ 2.00	≥ 10		hammer	2.0
Clay brick <sup>1), 6)</sup>	≥ 2.00	≥ 20		hammer	3.0
Calcium silicate brick <sup>2), 7)</sup>	≥ 2.00	≥ 20		hammer	3.0
Perforated ceramic brick <sup>1), 8)</sup>	≥ 0.80	≥ 15		rotary	1.2
Perforated ceramic brick <sup>1), 9)</sup>	≥ 0.80	≥ 15		rotary	2.5
Perforated ceramic brick <sup>1), 10)</sup>	≥ 0.80	≥ 15		rotary	2.5
Perforated ceramic brick <sup>1), 11)</sup>	≥ 1.20	≥ 12		rotary	1.5
Calcium silicate hollow block <sup>2), 12)</sup>	≥ 1.60	≥ 12		rotary	2.5
Lightweight concrete blocks <sup>3)</sup>	≥ 0.80	≥ 2		rotary	1.5
Aggregate concrete masonry units <sup>3), 14)</sup>	≥ 1.5	≥ 25		rotary	3.5
Aggregate concrete masonry units <sup>3), 15)</sup>	≥ 1.0	≥ 20		rotary	4.0









**KPR-FAST, KPS-FAST, KPR/FAST, KPS/FAST,  
KPR-STRONG and KPS-STRONG**

**Performances**  
Characteristic resistance in masonry (base material group b, c and d)

**Annex C4**  
of European  
Technical Assessment  
ETA-12/0272

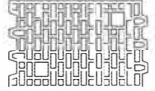
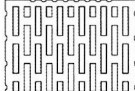
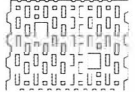
# Appendix 30/37

## extension of Table C4.1

Anchor type / Base material	Bulk density class [kg/dm <sup>3</sup> ]	Mean compressive strength class [N/mm <sup>2</sup> ]	Picture	Drill method	F <sub>Rk</sub> <sup>16)</sup> [kN]
<b>KPR-FAST 10/70 and KPS-FAST 10/70</b>					
Clay brick <sup>1), 5)</sup>	≥ 1.70	≥ 10		hammer	2.0
Clay brick <sup>1), 5)</sup>	≥ 1.70	≥ 20		hammer	3.5
Clay brick <sup>1), 6)</sup>	≥ 2.00	≥ 10		hammer	2.0
Clay brick <sup>1), 6)</sup>	≥ 2.00	≥ 20		hammer	3.0
Calcium silicate brick <sup>2), 7)</sup>	≥ 2.00	≥ 20		hammer	3.0
Perforated ceramic brick <sup>1), 8)</sup>	≥ 0.80	≥ 15		rotary	1.0
Perforated ceramic brick <sup>1), 9)</sup>	≥ 0.80	≥ 15		rotary	1.0
Perforated ceramic brick <sup>1), 10)</sup>	≥ 0.80	≥ 15		rotary	1.0
Perforated ceramic brick <sup>1), 11)</sup>	≥ 1.20	≥ 12		rotary	1.5
Calcium silicate hollow block <sup>2), 12)</sup>	≥ 1.60	≥ 12		rotary	2.5
Lightweight concrete blocks <sup>3)</sup>	≥ 0.80	≥ 2		rotary	1.5
Aggregate concrete masonry units <sup>3), 14)</sup>	≥ 1.5	≥ 25		rotary	3.5
Aggregate concrete masonry units <sup>3), 15)</sup>	≥ 1.0	≥ 20		rotary	4.0
Autoclaved aerated concrete element AAC 2 <sup>4)</sup>	≥ 0.35	≥ 2	-	rotary	0.9
Autoclaved aerated concrete element AAC 7 <sup>4)</sup>	≥ 0.65	≥ 6.5	-	rotary	2.0





**KPR-FAST, KPS-FAST, KPR/FAST, KPS/FAST,  
KPR-STRONG and KPS-STRONG**

**Performances**  
Characteristic resistance in masonry (base material group b, c and d)

**Annex C4**  
of European  
Technical Assessment  
ETA-12/0272

# Appendix 31/37

## extension of Table C4.1

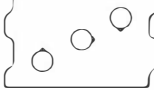
Anchor type / Base material	Bulk density class [kg/dm <sup>3</sup> ]	Mean compressive strength class [N/mm <sup>2</sup> ]	Picture	Drill method	F <sub>RK</sub> <sup>16)</sup> [kN]
<b>KPR-FAST 12 and KPS-FAST 12</b>					
Clay brick <sup>1), 5)</sup>	≥ 1.70	≥ 10		hammer	2.5
Clay brick <sup>1), 5)</sup>	≥ 1.70	≥ 20		hammer	3.5
Clay brick <sup>1), 6)</sup>	≥ 2.00	≥ 10		hammer	3.5
Clay brick <sup>1), 6)</sup>	≥ 2.00	≥ 20		hammer	3.5
Calcium silicate brick <sup>2), 7)</sup>	≥ 2.00	≥ 20		hammer	3.5
Perforated ceramic brick <sup>1), 11)</sup>	≥ 1.20	≥ 12		rotary	2.0
Calcium silicate hollow block <sup>2), 12)</sup>	≥ 1.60	≥ 12		rotary	3.0
Hollow lightweight aggregate concrete element <sup>3), 13)</sup>	≥ 0.80	≥ 2		rotary	2.0
Autoclaved aerated concrete element AAC 2 <sup>4)</sup>	≥ 0.35	≥ 2	-	rotary	0.75
Autoclaved aerated concrete element AAC 7 <sup>4)</sup>	≥ 0.65	≥ 6.5	-	rotary	3.0

**KPR-FAST, KPS-FAST, KPR/FAST, KPS/FAST,  
KPR-STRONG and KPS-STRONG**





**Performances**  
Characteristic resistance in masonry (base material group b, c and d)

**Annex C4**  
of European  
Technical Assessment  
ETA-12/0272

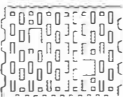

# Appendix 32/37

**extension of Table C4.1**

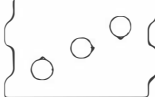
Anchor type / Base material	Bulk density class [kg/dm <sup>3</sup> ]	Mean compressive strength class [N/mm <sup>2</sup> ]	Picture	Drill method	F <sub>Rk</sub> <sup>16)</sup> [kN]
<b>KPR-FAST 14 and KPS-FAST 14</b>					
Clay brick <sup>1), 5)</sup>	≥ 1.70	≥ 10		hammer	4.0
Clay brick <sup>1), 5)</sup>	≥ 1.70	≥ 20		hammer	4.0
Clay brick <sup>1), 6)</sup>	≥ 2.00	≥ 10		hammer	4.0
Clay brick <sup>1), 6)</sup>	≥ 2.00	≥ 20		hammer	4.0
Calcium silicate brick <sup>2), 7)</sup>	≥ 2.00	≥ 20		hammer	4.0
Perforated ceramic brick <sup>1), 11)</sup>	≥ 1.20	≥ 12		rotary	2.0
Calcium silicate hollow block <sup>2), 12)</sup>	≥ 1.60	≥ 12		rotary	3.5
Hollow lightweight aggregate concrete element <sup>3), 13)</sup>	≥ 0.80	≥ 2		rotary	2.0
Autoclaved aerated concrete element AAC 2 <sup>4)</sup>	≥ 0.35	≥ 2	–	rotary	0.9
Autoclaved aerated concrete element AAC 7 <sup>4)</sup>	≥ 0.65	≥ 6.5	–	rotary	3.0
Partial safety factor $\gamma_{Mm}$ <sup>17)</sup>	2.5 / 2.0				
<sup>1)</sup> According to EN 771-1 <sup>2)</sup> According to EN 771-2 <sup>3)</sup> According to EN 771-3 <sup>4)</sup> According to EN 771-4 <sup>5)</sup> Polish clay brick; (L x W x H) = 250 x 120 x 65 mm <sup>6)</sup> German clay brick MZ Rd 2.0/20; (L x W x H) = 250 x 120 x 65 mm <sup>7)</sup> For example Kalksandstein KS NF 20-2.0 Vollstein according to DIN 106; (L x W x H) = 250 x 115 x 71 mm <sup>8)</sup> For example Porotherm 18.8; (L x W x H) = 468 x 188 x 238 mm <sup>9)</sup> For example Porotherm 25 P+W; (L x W x H) = 250 x 373 x 238 mm <sup>10)</sup> For example MAX 250; (L x W x H) = 250 x 373 x 238 mm <sup>11)</sup> For example HLZ Rd1 1.2/12 according to DIN 105; (L x W x H) = 308 x 240 x 238 mm <sup>12)</sup> For example KSL-R(P)8DF Lochstein according to DIN 106; (L x W x H) = 498 x 115 x 245 mm <sup>13)</sup> For example Hbl 2/0.8 Leichtbetonhohlstein according to DIN 18 151-100; (L x W x H) = 365 x 247 x 238 mm <sup>14)</sup> For example TeknoAmerBlok PK17,8; (L x W x H) = 178 x 390 x 190 mm <sup>15)</sup> For example TeknoAmerBlok PK19; (L x W x H) = 190 x 390 x 190 mm <sup>16)</sup> Characteristic resistance F <sub>Rk</sub> for tension, shear or combined tension and shear loading. The characteristic resistance is valid for single plastic anchor or for a group of two or four plastic anchors with a spacing equal or larger than the minimum spacing s <sub>min</sub> according to Table B3 (Annex B4). <sup>17)</sup> Partial safety factor for use in masonry $\gamma_{Mm}$ = 2,5 and partial safety factor for use in autoclaved aerated concrete $\gamma_{MAAC}$ = 2,0 in absence of other national regulations.					

**KPR-FAST, KPS-FAST, KPR/FAST, KPS/FAST,  
KPR-STRONG and KPS-STRONG**

**Performances**

Characteristic resistance in masonry (base material group b, c and d)

**Annex C4**  
of European  
Technical Assessment  
ETA-12/0272

Table C5.1: Displacements under tension and shear loading in masonry

Anchor type	Base material	Tension load			Shear load		
		F [kN]	$\delta_{NO}$ [mm]	$\delta_{N^{\infty}}$ [mm]	F [kN]	$\delta_{NO}$ [mm]	$\delta_{N^{\infty}}$ [mm]
KPR-FAST 8/50  KPS-FAST 8/50	Clay brick <sup>1), 6)</sup>	0.86	1.71	3.42	0.86	1.71	3.42
	Calcium silicate brick <sup>3), 7)</sup>	0.86	0.19	0.38	0.86	0.19	0.38
KPR-FAST 8/70  KPS-FAST 8/70	Clay brick <sup>1), 6)</sup>	0.86	0.35	0.70	0.86	0.35	0.70
	Calcium silicate brick <sup>2), 7)</sup>	0.86	0.20	0.40	0.86	0.20	0.40
	Perforated ceramic brick <sup>1), 9)</sup>	0.34	0.23	0.46	0.34	0.23	0.46
	Perforated ceramic brick <sup>1), 10)</sup>	0.34	0.23	0.46	0.34	0.23	0.46
	Calcium silicate hollow block <sup>2), 12)</sup>	0.71	0.31	0.62	0.71	0.31	0.62
	Hollow lightweight aggregate concrete element <sup>3), 13)</sup>	0.43	1.10	2.20	0.57	1.10	2.20
	Autoclaved aerated concrete element AAC 2 <sup>4)</sup>	0.21	0.42	0.84	0.21	0.42	0.84
	Autoclaved aerated concrete element AAC 7 <sup>4)</sup>	0.71	0.30	0.60	0.71	0.30	0.60

KPR-FAST, KPS-FAST, KPR/FAST, KPS/FAST,  
KPR-STRONG and KPS-STRONG

**Performances**  
Displacements in masonry

**Annex C5**  
of European  
Technical Assessment  
ETA-12/0272

# Appendix 34/37

**extension of Table C5.1**

Anchor type	Base material	Tension load			Shear load		
		F [kN]	$\delta_{NO}$ [mm]	$\delta_{N^\infty}$ [mm]	F [kN]	$\delta_{NO}$ [mm]	$\delta_{N^\infty}$ [mm]
<b>KPR/FAST 10</b> <b>KPS/FAST 10</b>	Clay brick <sup>1), 5)</sup>	1.00	0.20	0.40	1.00	0.83	1.25
	Clay brick <sup>1), 6)</sup>	1.00	1.07	2.13	1.00	0.83	1.25
	Calcium silicate brick <sup>3), 7)</sup>	1.00	0.09	0.18	1.00	0.83	1.25
	Perforated ceramic brick <sup>1), 9)</sup>	0.30	0.73	1.46	0.26	0.51	0.77
	Perforated ceramic brick <sup>1), 10)</sup>	0.30	0.73	1.46	0.26	0.51	0.77
	Perforated ceramic brick <sup>1), 11)</sup>	0.60	1.38	2.75	0.57	1.14	1.71
	Calcium silicate hollow block <sup>2), 12)</sup>	0.70	0.55	1.09	0.71	1.43	2.14
	Hollow lightweight aggregate concrete element <sup>3), 13)</sup>	0.43	1.35	2.70	0.57	1.14	1.71
	Autoclaved aerated concrete element AAC 2 <sup>4)</sup>	0.20	0.15	0.29	0.21	0.43	0.64
	Autoclaved aerated concrete element AAC 7 <sup>4)</sup>	0.50	0.02	0.04	0.54	1.07	1.61
<b>KPR-STRONG 10</b> <b>KPS-STRONG 10</b>	Clay brick <sup>1), 6)</sup>	1.00	1.10	2.20	1.00	0.83	1.25
	Calcium silicate brick <sup>2), 7)</sup>	1.00	0.15	0.30	1.00	0.83	1.25

**KPR-FAST, KPS-FAST, KPR/FAST, KPS/FAST,  
KPR-STRONG and KPS-STRONG**

**Performances**  
Displacements in masonry

**Annex C5**  
of European  
Technical Assessment  
ETA-12/0272

# Appendix 35/37

**extension of Table C5.1**

Anchor type	Base material	Tension load			Shear load		
		F [kN]	$\delta_{NO}$ [mm]	$\delta_{N^\infty}$ [mm]	F [kN]	$\delta_{NO}$ [mm]	$\delta_{N^\infty}$ [mm]
<b>KPR-FAST 10/50</b>  <b>KPS-FAST 10/50</b>	Clay brick <sup>1), 5)</sup>	0.6	0.1	0.2	0.6	0.9	0.6
	Clay brick <sup>1), 6)</sup>	0.9	0.5	1.0	0.7	1.1	0.7
	Calcium silicate brick <sup>3), 7)</sup>	0.9	0.3	0.6	0.7	1.1	0.7
	Perforated ceramic brick <sup>1), 8)</sup>	0.7	0.6	1.2	0.7	0.6	0.9
	Perforated ceramic brick <sup>1), 9)</sup>	0.7	1.0	2.0	0.7	0.5	0.8
	Perforated ceramic brick <sup>1), 10)</sup>	0.7	1.0	2.0	0.7	0.5	0.8
	Perforated ceramic brick <sup>1), 11)</sup>	0.4	0.5	1.0	0.4	0.4	0.6
	Calcium silicate hollow block <sup>2), 12)</sup>	0.7	0.6	1.2	0.7	0.5	0.8
	Lightweight concrete blocks <sup>3)</sup>	0.4	1.1	2.2	0.4	1.0	1.5
	Aggregate concrete masonry units <sup>3), 14)</sup>	1.0	0.4	0.8	1.0	0.5	0.75
	Aggregate concrete masonry units <sup>3), 15)</sup>	1.1	0.4	0.8	1.1	0.5	0.75

**KPR-FAST, KPS-FAST, KPR/FAST, KPS/FAST,  
KPR-STRONG and KPS-STRONG**

**Performances**  
Displacements in masonry

**Annex C5**  
of European  
Technical Assessment  
ETA-12/0272

# Appendix 36/37

extension of Table C5.1

Anchor type	Base material	Tension load			Shear load		
		F [kN]	$\delta_{N0}$ [mm]	$\delta_{N\infty}$ [mm]	F [kN]	$\delta_{N0}$ [mm]	$\delta_{N\infty}$ [mm]
KPR-FAST 10/70  KPS-FAST 10/70	Clay brick <sup>1), 5)</sup>	1.0	0.3	0.6	1.0	0.8	1.2
	Clay brick <sup>1), 6)</sup>	0.9	0.8	1.6	0.9	0.7	1.1
	Calcium silicate brick <sup>3), 7)</sup>	0.9	0.2	0.4	0.9	0.7	1.1
	Perforated ceramic brick <sup>1), 8)</sup>	0.3	0.5	1.0	0.3	0.4	0.6
	Perforated ceramic brick <sup>1), 9)</sup>	0.3	0.6	1.2	0.3	0.4	0.6
	Perforated ceramic brick <sup>1), 10)</sup>	0.3	0.6	1.2	0.3	0.4	0.6
	Perforated ceramic brick <sup>1), 11)</sup>	0.4	0.6	1.2	0.4	0.4	0.6
	Calcium silicate hollow block <sup>2), 12)</sup>	0.7	0.7	1.4	0.7	1.4	2.1
	Lightweight concrete blocks <sup>3)</sup>	0.4	1.0	2.0	0.4	1.0	1.5
	Autoclaved aerated concrete element AAC 2 <sup>4)</sup>	0.3	0.2	0.4	0.3	0.5	0.8
	Autoclaved aerated concrete element AAC 7 <sup>4)</sup>	0.7	0.3	0.6	0.7	0.7	1.1
	Aggregate concrete masonry units <sup>3), 14)</sup>	1.0	0.4	0.8	1.0	0.5	0.75
	Aggregate concrete masonry units <sup>3), 15)</sup>	1.1	0.4	0.8	1.1	0.6	0.9

**KPR-FAST, KPS-FAST, KPR/FAST, KPS/FAST,  
KPR-STRONG and KPS-STRONG**

**Performances**  
Displacements in masonry

**Annex C5**  
of European  
Technical Assessment  
ETA-12/0272

# Appendix 37/37

extension of Table C5.1

Anchor type	Base material	Tension load			Shear load		
		F [kN]	$\delta_{NO}$ [mm]	$\delta_{N^\infty}$ [mm]	F [kN]	$\delta_{NO}$ [mm]	$\delta_{N^\infty}$ [mm]
<b>KPR-FAST 12</b> <b>KPS-FAST 12</b>	Clay brick <sup>1), 5)</sup>	1.00	0.36	0.72	1.00	0.83	1.25
	Clay brick <sup>1), 6)</sup>	1.00	0.27	0.54	1.00	0.83	1.25
	Calcium silicate brick <sup>2), 7)</sup>	1.00	0.28	0.56	1.00	0.83	1.25
	Perforated ceramic brick <sup>1), 11)</sup>	0.57	0.72	1.44	0.57	1.14	1.71
	Calcium silicate hollow block <sup>2), 12)</sup>	0.86	0.43	0.86	0.86	1.71	2.57
	Hollow lightweight aggregate concrete element <sup>3), 13)</sup>	0.43	0.06	0.12	0.57	1.14	1.71
	Autoclaved aerated concrete element AAC 2 <sup>4)</sup>	0.27	0.39	0.78	0.27	0.54	0.80
	Autoclaved aerated concrete element AAC 7 <sup>4)</sup>	1.07	0.36	0.72	1.07	2.14	3.21
<b>KPR-FAST 14</b> <b>KPS-FAST 14</b>	Clay brick <sup>1), 5)</sup>	1.14	0.28	0.56	1.14	0.95	1.43
	Clay brick <sup>1), 6)</sup>	1.14	0.27	0.54	1.14	0.95	1.43
	Calcium silicate brick <sup>2), 7)</sup>	1.14	0.09	0.18	1.14	0.95	1.43
	Perforated ceramic brick <sup>1), 11)</sup>	0.57	0.13	0.26	0.57	1.14	1.71
	Calcium silicate hollow block <sup>2), 12)</sup>	1.00	0.16	0.32	1.00	2.00	3.00
	Hollow lightweight aggregate concrete element <sup>3), 13)</sup>	0.57	0.09	0.18	0.57	1.14	1.71
	Autoclaved aerated concrete element AAC 2 <sup>4)</sup>	0.32	0.39	0.78	0.32	0.64	0.96
	Autoclaved aerated concrete element AAC 7 <sup>4)</sup>	1.07	0.17	0.34	1.07	2.14	3.21
<sup>1)</sup> According to EN 771-1 <sup>2)</sup> According to EN 771-2 <sup>3)</sup> According to EN 771-3 <sup>4)</sup> According to EN 771-4 <sup>5)</sup> Polish clay brick; (L x W x H) = 250 x 120 x 65 mm <sup>6)</sup> German clay brick MZ Rd 2.0/20; (L x W x H) = 250 x 120 x 65 mm <sup>7)</sup> For example Kalksandstein KS NF 20-2.0 Vollstein according to DIN 106; (L x W x H) = 250 x 115 x 71 mm <sup>8)</sup> For example Porothersm 18.8; (L x W x H) = 468 x 188 x 238 mm <sup>9)</sup> For example Porothersm 25 P+W; (L x W x H) = 250 x 373 x 238 mm <sup>10)</sup> For example MAX 250; (L x W x H) = 250 x 373 x 238 mm <sup>11)</sup> For example HLZ Rd1 1.2/12 according to DIN 105; (L x W x H) = 308 x 240 x 238 mm <sup>12)</sup> For example KSL-R(P)8DF Lochstein according to DIN 106; (L x W x H) = 498 x 115 x 245 mm <sup>13)</sup> For example Hbl 2/0.8 Leichtbetonhohlstein according to DIN 18 151-100; (L x W x H) = 365 x 247 x 238 mm <sup>14)</sup> For example TeknoAmerBlok PK17,8; (L x W x H) = 178 x 390 x 190 mm <sup>15)</sup> For example TeknoAmerBlok PK19; (L x W x H) = 190 x 390 x 190 mm							

**KPR-FAST, KPS-FAST, KPR/FAST, KPS/FAST,  
KPR-STRONG and KPS-STRONG**

**Performances**  
Displacements in masonry

**Annex C5**  
of European  
Technical Assessment  
ETA-12/0272